



扫描二维码
下载说明书



扫描二维码
关注公众号

SHENZHEN GROWATT NEW ENERGY TECHNOLOGY CO., LTD
No.28 Guangming Road, Shiyan Street, Bao'an District, Shenzhen, P.R. China

T: +86 755 27471942
E: service@ginverter.com
W: www.ginverter.com

GR-UM-175-A-00



Installation & Operation Manual

Contents

1 Overview

- 1.1 Product Overview
- 1.2 Applicable Personnel

2 Safety Precautions

- 2.1 Safety Overview
- 2.2 Symbol Conventions
- 2.3 Label Description

3 Product Introduction

- 3.1 Appearance
- 3.2 Size Dimensions
- 3.3 Nameplate
- 3.4 Working Principle
- 3.5 Inverter Storage
- 3.6 Grid Types

4 Unpacking

5 Installation

- 5.1 Basic Installation Requirements
- 5.2 Installation Environment Requirements
- 5.3 Moving Requirements
- 5.4 Wall Mounted Bracket Installation
- 5.5 Installing PV Inverter

6 Electrical Connections

- 6.1 AC side Connection
- 6.2 DC side Connection
- 6.3 Communication Connection
- 6.4 Protective Ground Connection
- 6.5 Lightning Protection Grounding

7 Debugging

- 7.1 Debug Inverter
- 7.2 Operating Mode
- 7.3 OLED Display and Touch Buttons

8 Monitoring Method

- 8.1 Remote Data Monitoring
- 8.2 Local Data Monitoring

9 System Maintenance

- 9.1 Routine Maintenance
- 9.2 Trouble Shooting

10 Product Specification

11 Decommissioning

12 Quality Assurance

13 Contact Us

1 Overview

1.1 Product Overview

This manual is aimed at providing sufficient information and installing instruction for consumers buying Shenzhen Growatt New Energy Technology Co. Ltd (short as Growatt) MAC Series solar inverters. Please read this manual carefully before using the MAC series inverters and store the manual in a reachable place for an authorized technician. No further notice if there is any change in this manual.

1.2 Applicable Personnel

Only qualified electrical technicians are allowed to install MAX series inverter. With reading through this manual and following all the precautions, qualified electrical technician can properly install MAC serial inverter, finish trouble shooting and communication settings.

If there is any problem during the installation, the installer can either log on www.ginverter.com and leave a message or call consumer service hotline +86 755 27471942.

2 Safety Precautions



2.1 Safety Overview

- 1> Before installation please make sure reading through this manual, any damage caused by improper installation, Growatt reserve the right to disclaim any warranty.
- 2> All the operations and connections must be done by trained qualified electrical technician.
- 3> During installation except for terminals, do not touch any inside part of the inverter.
- 4> All the electrical connections must meet local country's safety regulations.
- 5> If you need maintenance for this inverter, please contact our local authorized installing and maintenance technician.
- 6> You must get the local power supplier's permit before connecting this inverter to the grid.
- 7> When installing PV modules during the day, use opaque materials to cover the PV modules. Otherwise, the voltage at the component terminals is high in the sun, which may cause personal danger.

Handle Process :



 WARNING	<ul style="list-style-type: none"> The inverter is heavy, please treat with care while handling, in case of crushing injury.
---	---

Installation :



 NOTICE	<ul style="list-style-type: none"> Before installation, please read through this manual, any damage caused by improper installation, Growatt reserve the right to disclaim any warranty.
 DANGER	<ul style="list-style-type: none"> Ensure that the MAC is not connected to a power supply and is not power on before installation.

 WARNING	<ul style="list-style-type: none"> Please follow this installation manual as installation condition environment, space and so on. Please install the inverter in a dry and ventilated environment, otherwise may affect the performance of the inverter. Please follow the installation procedures in this manual.
---	---



Electrical Connections:

 DANGER	<ul style="list-style-type: none"> Before electrical connection, please ensure the inverter DC switch is at " OFF" also disconnect AC switch, otherwise the high voltage from inverter may cause life risk. Only trained authorized electrical technician can do the electric connection also please follow the connection procedures in this manual along with local country's regulations. High voltage may cause electric shocks and serious injury please do not touch the inverter. Please do not store inverter in area with flammable and explosive material.
 WARNING	<ul style="list-style-type: none"> Each inverter must install one AC breaker; AC breaker is forbidden to share with other inverters. It is forbidden to add load between inverter and breaker. If the cable is thick, after tightening the cable do not shake it and ensure the cable is well-connected and then start the inverter. Loose connection may cause overheat. Before connecting between PV panels and inverter please ensure the positive and negative poles are correct connected.





Maintenance and replacement:

 DANGER	<ul style="list-style-type: none"> Must be installed by trained and authorized electrical technician and accurately follow this manual. Please disconnect the DC and AC switch for at least five minutes, all the operations should be carried after power disconnection. If there is PV isolation low alarm, the inverter case may be ungrounded, please do not touch the inverter case. High voltage of inverter may result in electric shock.
 WARNING	<ul style="list-style-type: none"> For better cooling purpose, please regularly clean the fans. Do not use air pump to clean the fans, cause it may damage the fans.









Other :

	<ul style="list-style-type: none"> •After you receiving the inverter please check the packing materials for damage,if there is any damage please contact your supplier.
 WARNING	<ul style="list-style-type: none"> •The Max. PV input voltage should not exceed 1100V. •For the disposed inverter,the consumer should dispose it according to local disposal rules for electrical equipment waste.

2.2 Symbol Conventions

Symbol	Description
 DANGER	Indicates an imminently hazardous situation which,if not avoided,will result in serious injury or death.
 WARNING	Indicates potentially hazardous situation which,if not avoided, will result in serious injury or death.
 CAUTION	Indicates potentially hazardous situation which,if not avoided, will result in minor or moderate injury.
 NOTICE	Indicates certain hazardous situation which,if not avoided,will result in property damage.
	Reminds operator to read installation manual before operating or installing inverter.

2.3 Lable Description

Symbol	Name	Meaning
	High Voltage Electric Shock	Inverter operating with high voltage,any operation regarding inverter need to be done by trained and authorized electrical technician.
	Burn Warning	Do not touch a running inverter cause it generates high temperature on the case.
	Protective Grounding	Connect inverter to grounding bar.
	Delay discharge	Residual voltage exists after the inverter is powered off,it takes 5 minutes for the inverter to discharge to the safe voltage.
	Read the installation manual	Reminds operator to read installation manual before operating or installing inverter.
	DC	Means this terminal is for DC side.
	AC	Means this terminal is for AC side.
	CE Mark	The inverter complies with the requirements of the applicable CE guidelines

3 Product Introduction

3.1 Appearance

Front view:

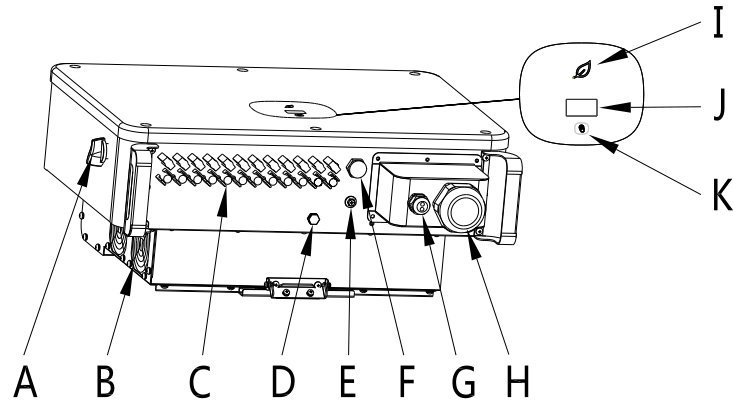

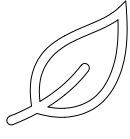

Figure 3.1

Mark	Description	Mark	Description
A	DC switch	G	485 Waterproof connector
B	Fan	H	AC Waterproof connector
C	PV input terminal	I	LED Indicator light
D	Breathable valve	J	OLED Screen
E	Safety ground terminal	K	Touch button
F	USB interface		

Identification	Description	Explanation
	Touch mark	Touch button to switch OLED display and set parameters by touch
	Inverter status identification	Indicates the current operating status of the inverter: 1. Red: Fault 2. Green: normal operation 3. Red light flashes: warning 4. Green light flashes: update program

3.2 Size Description

Model	Size (unit : mm)			Weight (unit: kg)
	Width	High	Deep	
MAC series PV inverter	680	508	281	52
MAC series PV Inverter with packaging	730	650	350	60

3.3 Nameplate

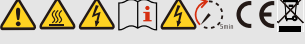
 PV Grid Inverter	
Model name	MAC 60KTL3-X LV
Max. PV voltage	1100 d.c.V
PV voltage range	200-1000 d.c.V
PV Isc	55 d.c.A*3
Max. input current	50 d.c.A*3
Max. output power	60000 W
Max. apparent power	66600 VA
Nominal output voltage	3W/N/PE 230/400 a.c.V
Max output current	96.6 a.c.A
Nominal output Frequency	50/60 Hz
Power factor range	0.8leading-0.8lagging
Safety level	Class I
Ingress Protection	IP65
Operation Ambient Temperature	-25°C - +60°C
	
Made in China	

Note: The MAC series inverter nameplate is similar to the nameplate shown above, but the product model and specific parameters are different. See Chapter 10 Product Specifications for specific parameters.

3.4 Working Principle

Mac inverter's working principle is like following:

- 1>The PV panels gather solar to generate DC power to inverter.
- 2>With input current detection circuit, it can monitor all the PV panels' working status and use MPPT to track the maximum power point.
- 3>With inverter circuit change DC power to AC power, and feed power back to grid per grid requirement.
- 4>With output isolation relay can isolate AC output and grid, if anything goes wrong on either inverter side or grid side, isolation relay can disconnect inverter immediately.

On-grid connection system diagram:

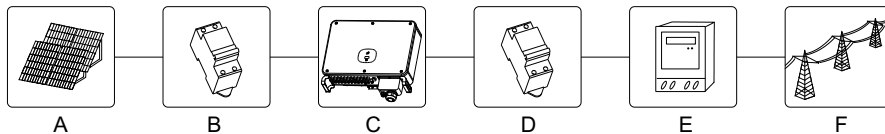

Figure 3.2

Mark	Description	Mark	Description	Mark	Description
A	Photovoltaic module	C	PV inverter	E	Meter
B	DC circuit breaker	D	AC circuit breaker	F	Grid

3.5 Inverter Storage

- 1>Do not unpack the Inverter and store it in a ventilation dry place.
- 2>Keep the storage temperature at -25°C ~ +60°C and humidity at 0-95%.
- 3>A maximum of four inverters with package can be stacked.
- 4>If the inverter has been long-term stored, inspections and tests should be conducted by qualified personnel before it is put into use.

3.6 Grid Type

In the MAC series, the MAC 30-60KTL3-X LV model grid connection method is shown in Figure 3.3, and the MAC 50-70KTL3-X MV model grid connection method is shown in Figure 3.4, and the MAC 15-36KTL3-XL model grid connection method is shown in Figure 3.5.

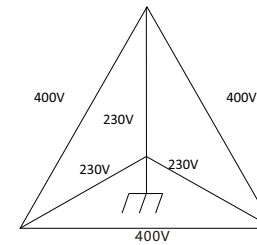

Figure 3.3

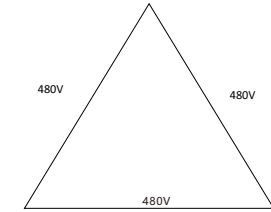

Figure 3.4

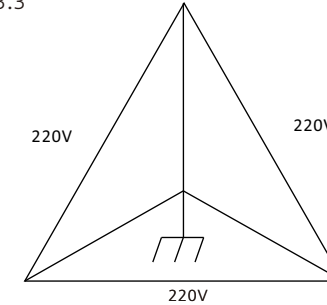

Figure 3.5

4 Unpacking

Checking before installation

- 1>Before unpacking the inverter, check the outer packing materials for damage.
- 2>After unpacking the inverter, check that the contents are intact and complete. If any damage is found or any component is missing, contact your supplier.

The MAC series inverter accessories are as follows :

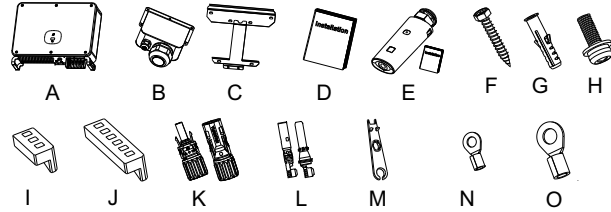



Figure 4.1

No.	Description	Qty.	No.	Description	Qty.
A	PV inverter	1	L	PV+/PV- metal terminal	8/8 ^a
B	AC Protective cover	1			9/9 ^b
C	Wall mount	1			10/10 ^c
D	User manual	1			12/12 ^d
E	Data collector / manual (optional)	1/1	M	PV Removal tool	1
F	Self-tapping screw	5	N	RNBS14-6	1
G	Plastic expansion tube	5	O	SC50-10	5
H	Safety screw	1	*	Warranty card	1
I	485 terminal (3PIN)	1	*	Copy of the business license	1
J	485 terminal (6PIN)	1	*	Certificate	1/1
K	PV+/PV- terminal	8/8 ^a 9/9 ^b 10/10 ^c 12/12 ^d	Note: 1.a:MAC 30KTL3-X;b: MAC 40KTL3-X;c:MAC 50KTL3-X;d:others; 2.The MAC series comes standard with 50-10 copper crimp terminals. If you have copper and aluminum terminals, please contact the supplier.		

Installation5



WARNING

- To prevent device damage and personal injury, keep balance when moving the inverter because it is heavy.
- Do not place the inverter with its wiring and signal terminals at the bottom contacting with floor or any other object because the terminals are not designed to support the weight of inverter.
- When placing inverter on the floor, put foam or paper under the inverter to protect its cover.

5.1 Basic Installation Requirements

- A.Ensure that the installation wall is solid enough to bear the inverter.(Inverter weight please refer to installation manual Figure 5.1)
- B. There must be enough installation space to fit the size of inverter.
- C. Do not install inverter on flammable or heat-intolerant buildings.
- D.This inverter is IP 65 protection, you can install it indoor or outdoor.
- E. Install the inverter in the eye for easy viewing of the OLED display and maintenance work.
- F.To avoid inverter performance de-rate due to the over heat, please do not expose the inverter under direct sunlight.
- G.The installation humidity should be from 0-95%.
- H.The surrounding temperature of inverter should be from -25°C ~ +60°C.
- I.Inverter should be installed in a vertically or rear tilted surface, please refer to following drawings.

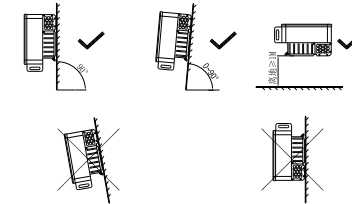



Figure 5.1



NOTICE

When the equipment is placed horizontally, the height from the ground must be more than 1 meter.

J.To ensure the inverter can work smoothly and easy for personnel to operate, please notice there is sufficient space for inverter, refer to following drawing :

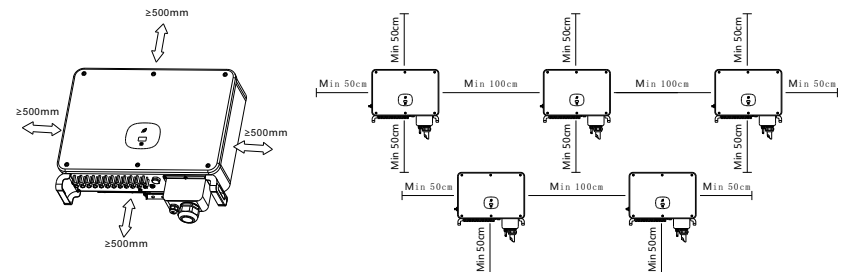

Figure 5.2

- K. Do not install inverter close to strong electromagnetic signal.
- L. Install the inverter out of children's reach.

5.2 Installation Environment Requirements

A. Although the inverter's protection level is IP 65, to extent inverter lifespan you still need to avoid rain and snow, please refer to following drawings.

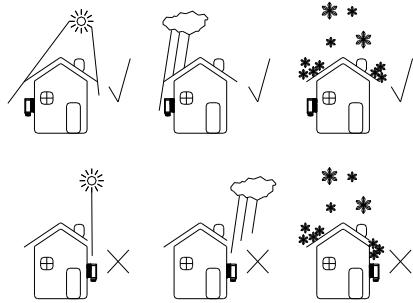

Figure 5.3

B. To reduce the de-rate performance of the inverter and extend inverter's life span, we strongly recommend you install an awning, for the distance between an awning and inverter, please refer to following drawing.

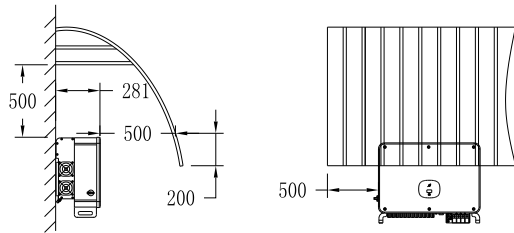

Figure 5.4

D. Do not install inverter into an enclosed space like following drawing :

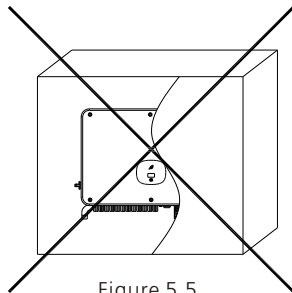

Figure 5.5

5.3 Moving Requirements



WARNING

- The inverter is heavy, please move it with care and keep balance to avoid personnel injury.
- Do not place the inverter with its wiring and signal terminals at the bottom contacting with floor or any other object because the terminals are not designed to support the weight of inverter.

1>2-3 people put their hands into the package, lift the inverter out of the package, and move to the designated installation location.

2>When you are moving the inverter, please keep the balance.

Notice: There is front and bottom mark on the package.

5.4 Wall Mount Bracket Installation

Before install the inverter you need install the wall mount bracket so that the inverter can be firmly installed on the wall.

Wall mount plane drawing :

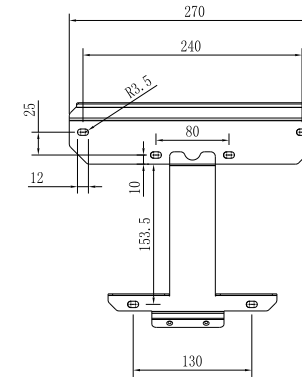

Figure 5.6



DANGER

To avoid electric shock or other damage, be sure to check the wall for power lines or other piping before opening the wall.

Steps:

1>Use the wall mount plate as a template drill holes on the wall and put in expansion bolts.

2>Follow the following drawing put the bolt to install the wall mount plate on the wall.

Electrical Connections 6

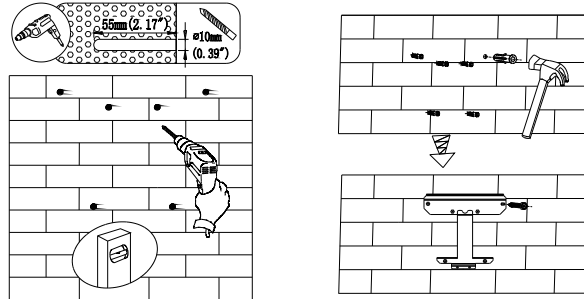

Figure 5.7

5.5 Install PV Inverter

- 1> Before installing the inverter on the wall mount, please make sure that the wall mount is firmly fixed to the wall:
- 2> Hang the inverter on the wall mount and fix it with bolts. Keep the inverter balanced when hanging.
- 3> Check the inverter if it is firm enough and lock all the screws.

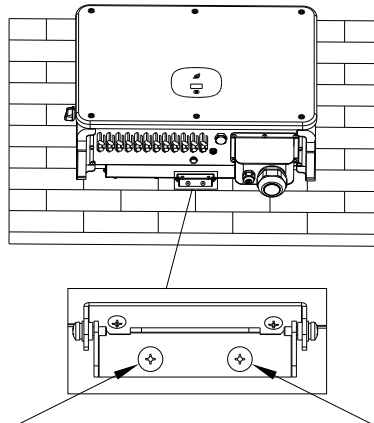

Figure 5.8

6.1 AC Side Connection

 DANGER	<ul style="list-style-type: none"> • Before electrical connection, please ensure the inverter DC switch is at "OFF" also disconnect AC switch, otherwise the high voltage from inverter may cause life risk. • Only trained authorized electrical technician can do the electric connection also please follow the connection procedures in this manual along with local country's regulations. • High voltage may cause electric shocks and serious injury please do not touch the inverter. • Please do not store inverter in area with flammable and explosive material.
 WARNING	<ul style="list-style-type: none"> • Each inverter must install one AC breaker, AC breaker is forbidden to share with other inverters. • It is forbidden to add load between inverter and breaker. • If the cable is thick, after tightening the cable do not shake it and ensure the cable is well-connected and then start the inverter. Loose connection may cause overheat.

Preparation before connection:

1. Disconnect inverter DC switch and AC breaker or switch
2. When the AC wire is tightened, the torque of the PE grounding is 35kgf.cm, and the other torque is 50kgf.cm.
3. Measure the grid voltage and frequency. For detailed parameters, please refer to Chapter 10 Product Specifications.

AC circuit breaker specifications:

PV inverter model	Circuit breaker specifications
MAC 30KTL3-X LV	64A/400Vac
MAC 40KTL3-X LV	80A/400Vac
MAC 50-60KTL3-X LV	100A/400Vac
MAC 50KTL3-X MV	80A/ 480Vac
MAC 60-70KTL3-X MV	100A/480Vac
MAC 15-20KTL3-XL	63A/220Vac
MAC 22-25KTL3-XL	80A /220Vac
MAC 30-36KTL3-XL	100A /220Vac

Cable specifications refer to the following table:

PV Inverter	Cross-sectional area(mm ²)		Recommended value(mm ²)	
	Copper wire	Aluminum wire	Copper wire	Aluminum wire
MAC 30KTL3-X LV	10-35	25-50	16	25
MAC 40KTL3-X LV	25-35	35-50	30	35
MAC 50-60KTL3-X LV	25-35	35-50	35	50
MAC 50KTL3-X MV	25-35	35-50	30	35
MAC 60-70KTL3-X MV	25-35	35-50	35	50
MAC 15KTL3-XL	10-35	35-50	16	25
MAC 20-25KTL3-XL	25-35	35-50	30	35
MAC 30-36KTL3-XL	25-35	35-50	35	50

Notice: The cable must be unbroken.50

AC terminal wiring steps:

A. The following figure shows the AC terminal on the inverter. L1, L2, and L3 are three fire channels, and N is a nature channel.

Note: The screws are matched with M8 screws.

B. Determine the stripping length according to the specifications of the crimping terminal (recommended 16-18mm), crimp the wire and terminal with the crimping pliers, then pass the cable through the protective casing, lock it on the corresponding AC terminal, and tighten the terminals Screw.

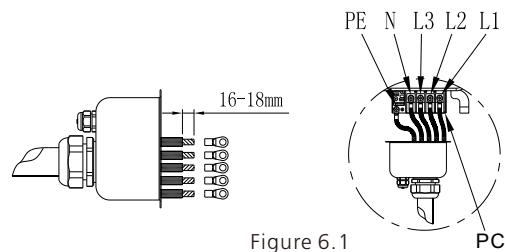

Figure 6.1

C. Connect the MP cable of the AC terminal with the matching M4 screw. After the RS485 is connected, lock the protective casing on the inverter frame.

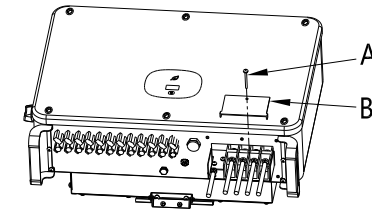

Figure 6.2

D. Lock the protective casing on the inverter frame and block the waterproof joint with fireproof mud to prevent water ingress

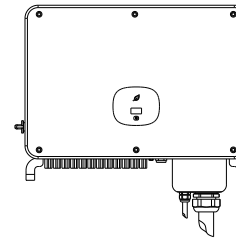

Figure 6.3

Notice: Waterproof joints must be blocked with fireproof mud to prevent water ingress.

6.2 DC Side Connection

 DANGER	<ul style="list-style-type: none"> • Before electrical connection, please ensure the inverter DC switch is at "OFF" also disconnect AC switch, otherwise the high voltage from inverter may cause life risk. • Only trained authorized electrical technician can do the electric connection also please follow the connection procedures in this manual along with local country's regulations.
	<ul style="list-style-type: none"> • High voltage may cause electric shocks and serious injury please do not touch the inverter. • Please do not store inverter in area with flammable and explosive material.

Notice: The sunlight will generate voltage on the solar panels, after serial connection, the high voltage may injure personnel, so before connect DC input cable you need cover solar panels with light-tight materials and make sure the inverter DC switch is at "OFF" status, otherwise high voltage may injure personnel.

 WARNING	<ul style="list-style-type: none"> • Each string's maximum open circuit voltage cannot exceed 1100Vdc, otherwise it could lead to fire or damage the inverter. • If the inverter was damaged by higher maximum open circuit voltage (higher than 1100Vdc) product warranty will be forfeited and Growatt will not take any responsibility..
--------------------	---

- A. Each string solar panels should be same brand and same model.
- B. The total panels power should not exceed 1.25 times of inverter input power.
- C. According to the specification of the crimping terminal, determine the stripping length (recommended 8-10, mm), crimp the wire and terminal with the crimping pliers, and connect them to the corresponding connector housings separately, and hear the click sound to ensure the connection is good. The picture shows the connection of the DC terminal.

Notice: Connectors need to be fit with male and female terminals, before connecting panels with inverter please make sure the positive pole and negative pole, namely the solar panels' positive pole connect to "+" negative pole connect to "-".

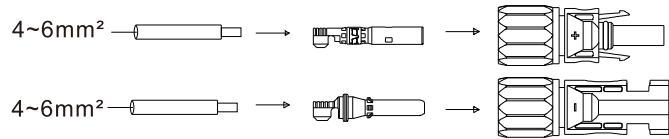

Figure 6.4

- D. The positive and negative terminals of the panel are connected to the corresponding terminals of the inverter. For the maximum input current value of each MPPT of different types of inverters, please refer to the following table :

PV inverter	Maximum input current per MPPT
MAC 30KTL3-X LV	12.5A*3/12.5A*3/12.5A*2
MAC 40KTL3-X LV	12.5A*3/12.5A*3/12.5A*3
MAC 50KTL3-X LV	12.5A*4/12.5A*3/12.5A*3
MAC 60KTL3-X LV	12.5A*4/12.5A*4/12.5A*4
MAC 50KTL3-X MV	12.5A*4/12.5A*3/12.5A*3
MAC 50-70KTL3-X MV	12.5A*4/12.5A*4/12.5A*4
MAC 15-36KTL3-XL	12.5A*4/12.5A*4/12.5A*4

- E. Panel component configuration recommendation table:

MPPT	PVA	PVB	PVC
12 Strings	●●●●	●●●●	●●●●
11 Strings	●●●●	●●●●	●●●○
10 Strings	●●●●	●●●○	●●●○
9 Strings	●●●○	●●●○	●●●○
8 Strings	●●●○	●●●○	●●○

Notice: When there is a hanging string in each MPPT, it is necessary to add a dust plug for waterproof treatment.

- F. Cable specification requirements:

PV inverter model	Cross-sectional area (mm ²)	Recommended value (mm ²)	Line outer diameter range (mm ²)
MAC series PV inverter	4-6	4	4.5-7.8

Notice :

1. Under any circumstance, the total current of all strings cannot exceed the inverter's maximum current.
2. Do not touch any working solar panels.
3. Make sure the cable is unbroken.

6.3 Communication Connection

6.3.1 RS 485

The MAC series comes standard with two RS485 interfaces, and you can monitor one or more inverters via RS485. Another RS485 port is used to connect the smart meter (single machine anti-backflow function). When connecting the RS485 communication line to a single unit, please follow the instructions below.

- 1>Loosen the AC protective cover and remove the protective cover;
- 2>Pass the RS 485 communication cable through the waterproof rubber plug and connect to the RS485 interface;
- 3>The inverter is connected hand-in-hand through the RS 485 communication line. The RS485A1 and RS485B1 (4/5/6 port or 7/8/9 port) at the end of the 485 cable are connected to the ShineMaster for remote server monitoring
- 4>Lock the protective casing on the inverter frame to prevent water ingress.

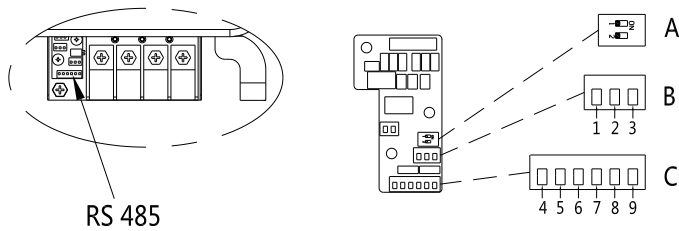

Figure 6.5

No.	Definition	Description
1	RS485B2	RS485A2 / B2: Anti-backflow communication port, connected to smart meter
2	GND	
3	RS485A2	
4 / 7	RS485B1	RS485A1 / B1: The customer uses the communication port to connect to the third-party monitoring equipment
5 / 8	GND	
6 / 9	RS485A1	

When multiple machines are connected in parallel, two customers use RS485 wiring ports (4/5/6 and 7/8/9 ports) at the same time, and use multiple twisted pairs with shielding layers to connect multiple inverters by hand. Parallel connection through the RS485 communication line, an inverter (defined as the first) is connected to the monitoring equipment to achieve multi-machine monitoring, the number of parallel machines can reach 32 units. When multiple machines are connected in parallel or the transmission distance is long, it is recommended to switch the DIP switch 2 of the last inverter from the left side to the right side to introduce a matching resistor. Refer to the following figure for wiring:

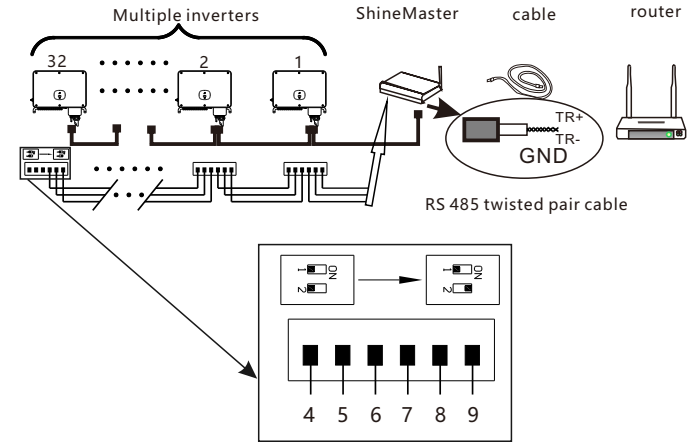

Figure 6.6

6.3.2 USB

- The USB port is mainly used to connect to the monitoring module or firmware update:
- External optional data collector (Shine GPRS-X , Shine WiFi-X , Shine4G-X) , Can be connected to the USB interface for monitoring.
- Quickly update software with U disk.
- Steps for installing the monitoring module: Make sure ▲ is on the front side, then insert the display and tighten the screws.

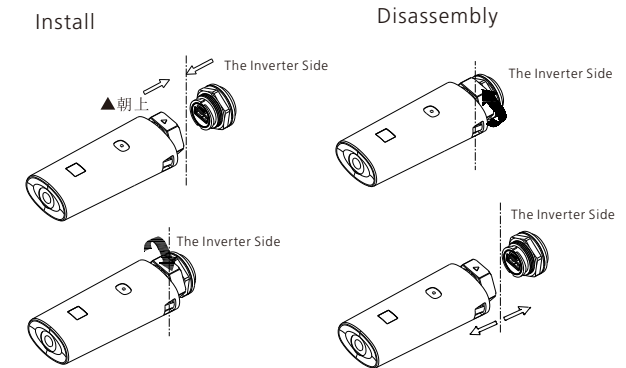

Figure 6.7

6.4 Protective Ground Connection

In this solar system all the unloaded metal components and cases should be connected to the ground.

Single inverter need grounding over a PE point, multiple inverters need connect all the inverter PE cable and solar panels shelves to the same grounding point to achieve equipotential.

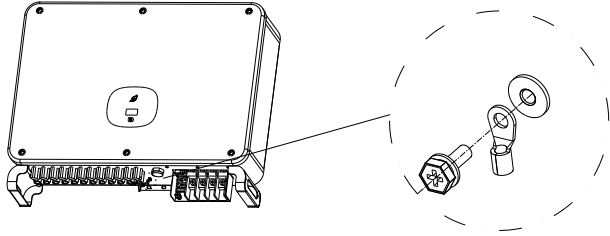

Figure 6.8

Note: Pay attention to the rain at the grounding wire terminal joint. Do not expose it directly to the air. The recommended torque value for tightening the screw is 25kgf.cm.

6.5 Lightning Protection Grounding

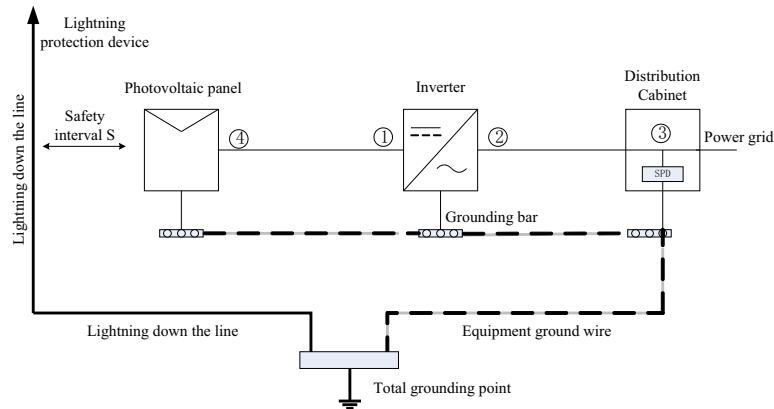

Figure 6.9

1>It is generally recommended to install lightning protection devices (generally referred to as lightning rods or lightning protection belts and down conductors at the top of the building) to prevent lightning from hitting the PV array. (Note1)

2>Lightning protection devices and down-conductors and related equipment in photovoltaic systems (including photovoltaic panels, inverters, cables, power distribution equipment) shall maintain a safe separation distance S ; Suggested value of S : According to the general 5 storey height (about 15m) building roof, S takes 2.5m enough, this distance can be simplified according to the inverse relationship of the floor height. (Note2)

3>The lightning down conductor and the equipment ground wire eventually sink at a total ground point, but the two cannot share the wire. That is, the equipment grounding wire should be pulled separately, and the wire diameter requirement is $>6\text{mm}^2$ when the safety interval distance S is satisfied; (Note4)

4>Refer to GB/T 21714.3-2015 for the relevant design of the above lightning protection lightning receptor system.

Note1:Refer to IEC 61643-32 <Low Voltage Surge Protector (SPD) Part 32: Surge Protectors Connected to the DC Side of Photovoltaic Devices—Selection and Use Guide>, Appendix C.

Note2:Refer to GB/T 21714.3-2015 <Lightning Protection Part 3 _ Physical Damage and Life Danger of Buildings>, 6.3.1.

Note3:Refer to 6.2.2 and 6.2.3 of IEC 61643-32.

Note4:Refer to Chapter 7 and Appendix C of IEC 61643-32.



WARNING

The lightning protection measures for photovoltaic systems shall be carried out in accordance with the corresponding national standards and IEC standards. Otherwise, photovoltaic devices such as components, inverters and power distribution facilities may be damaged by lightning. In this case, the company does not carry out warranty and assumes any responsibility.

7 Debugging

7.1 Debug Inverter

- 1>Close the DC switch on the inverter. As long as the input DC voltage is greater than 250V, the inverter display will display the following message: If there is no mains connection error, the inverter LED will turn red. If other information is displayed, please refer to Chapter 9. If the debugging process encounters an unsolvable problem, please contact customer service and perform the next step.
- 2>Close the circuit breaker or switch between the inverter and the grid. The inverter starts the self-test countdown. After the self-test is normal, it will be connected to the grid.
- 3>In normal operation, the leaves of the inverter indication window will turn green.
- 4>Complete debugging.



If the inverter is stored over one month, its default time and date may look wrong, the time and date should be reset before connection to the grid.

7.1.1 Set the PV inverter Communication Address

After the inverter is turned on normally, the inverter communication address can be set through RS485, USB to WIFI module or server webpage. When the inverter is connected by RS485 and multi-machine parallel communication, the inverter should be set to different communication address; when the single machine communicates, the factory default communication address can be used directly. Note: The inverter communication address can be set from 1 to 254.

7.1.1.1 ShineBus Sets the Communication Address

The communication address of the inverter can be modified by the PC software ShineBus, which is performed by a professional.

7.1.1.2 Mobile APP Set Communication Address

Refer to Section 8.2 Local Data Monitoring, download the mobile app and log in to the monitoring interface to modify the communication address. This operation is performed by a professional.

- 1>Select "Parameter Settings".
- 2>Enter the control password. (First time you need to set the control password, click "Reset Password", jump to the page, enter the OSS account and password, the distributor and installer can apply for the OSS account to Growatt, click "Login", set Control password, the relevant settings can be used after the setting is successful.)
- 3>Select the setting item "Communication Address".
- 4>Click "Read" in the upper right corner to get the original communication address of the machine.
- 5>Set the inverter communication address.
- 6>Read the inverter communication address and confirm that the setting is successful.

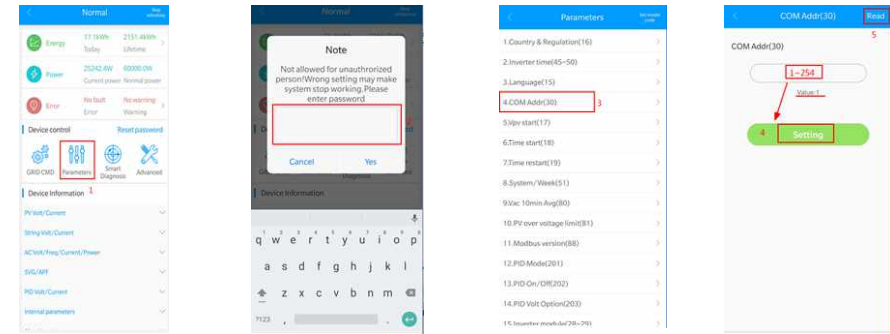

Figure 7.1

7.1.1.3 Server WEB Page Set Communication Address

Refer to Section 8.1.2 to log in to the server. After obtaining the inverter data through the collector, modify the device communication address. This operation is performed by a professional.

- 1>Click "Settings" in "device list" to enter the advanced settings page;
- 2>Read the "30" register to get the current device address, the password is max + today date (such as August 7th: max20190807);
- 3>When setting a new communication address, write the value of the "30" register as the address to be set (1~254), and then click "Save";
- 4>After setting the communication address, you can read the value of the "30" register to confirm whether the setting is successful.



Figure 7.2



Figure 7.3

7.1.2 Set Inverter Time and Date

Refer to Section 8.2.1 to log in to the mobile APP. After the mobile phone communicates normally with the inverter through the APP, click "Parameter Configuration" and select "System Time (45~50)" to set the inverter time and date.



Figure 7.4

7.2 Operating Mode

At this mode, inverter will check the system parameter. If the system is normal and PV voltage is more than 250VDC, inverter will try to connect to the grid.

7.2.1 Waiting Mode

In this mode, the inverter works normally, the leaf of the indication window turns green, and the LED display shows the active power and apparent power.

When the DC voltage is more than 250V DC, inverter will send the AC current converted from PV module DC to the grid.

When the DC voltage is lower than 250VDC, inverter will enter into "waiting" and try to connect to the grid, at this status, inverter consume very small power to check the internal system status.

Note: only when the PV modules supply enough power(voltage > 200VDC) then the inverter will start automatically.

7.2.2 Failure Mode

The intelligent control system of the inverter constantly monitors and adjusts the state of the system. When the inverter detects any fault, the leaf of the indication window is steady red or flashing red, and the LED display shows the fault message.

Note: please refer to section 9.2 to check the fault message and take corrective measures.

7.2.3 Shutdown Mode

When the sunlight is weak or no light, inverter will stop working automatically. When it is off, inverter will not consume grid power or PV module. At the same time, the OLED lamp and LED display of the inverter will be extinguished.

Note: When PV string DC voltage is too low ($\leq 150\text{VDC}$), inverter will be off.

7.3 OLED Display and Touch Buttons

The OLED display can display the operating status of the inverter and various parameter information. The touch panel can be used to switch the display interface of the inverter and set the inverter parameters.

Touch mode	Definition
single	Switch or current number plus 1
Two consecutive times	Go to Settings & OK
Three consecutive times	Return to the previous display interface
Long press 5S	Current data is zeroed

7.3.1 Boot Display

When the inverter is turned on, the OLED display interface is as follows:

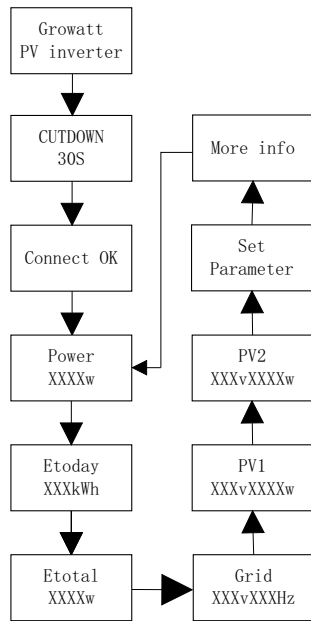

Figure 7.5

7.3.2 OLED Display Wake Up

After the inverter works normally for 5 minutes, the OLED display will be automatically turned off. At this time, the OLED has no display, the leaf of the indication window is green, and the display data needs to be viewed or set. The OLED can be redisplayed by touch operation.

7.3.3 Function Setting

	The inverter can support multiple touch mode modes: single touch, two consecutive touches, three consecutive touches, and long press 5S. Different types of taps have different functions. Advanced setup password: 111	
	Touch mode	definition
	single	Move, turn page or current number plus 1
	Two consecutive times	Enter setup mode, confirm settings
	Three consecutive times	Return to the previous display interface
	Long press 5S	Current data is zeroed

All settings interface is as follows:

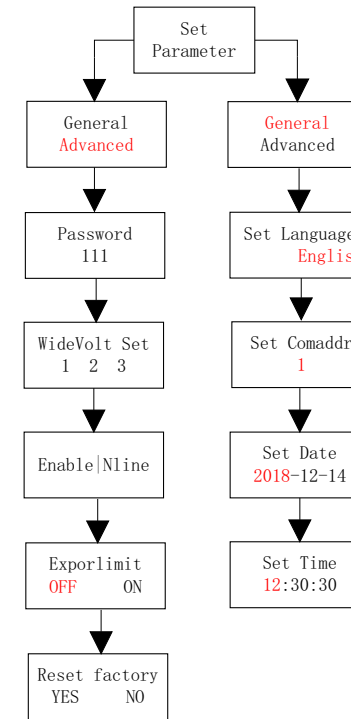

Figure 7.6

7.3.3.1 Select Protection Voltage Level

The inverter is factory set to CQC standard regulations, customers can choose different voltage protection levels according to the actual situation; single touch switching voltage level, continuous touch twice to confirm the setting.



Figure 7.7

- 1 standard
- 2 wide voltage level 2
- 3 wide voltage level 3

Tips and Disclaimers

The grid voltage and frequency of the inverter are set according to NB/T 32004-2013 or the latest domestic standard. If the grid voltage is close to or higher than the domestic regulations, the inverter cannot be connected to the grid and the local power operator can obtain the voltage level. According to the voltage of the grid connection point, the user can select other voltage levels.

	Excessive voltage of the power grid may affect the normal use and service life of the household appliances on the grid side, or cause loss of power generation. Due to the related effects and consequences caused by the integration of the output voltage automatic control function, we do not recognize any responsibility
--	--

7.3.3.2 Language Setting

The default language is Chinese, press the touch twice to enter the setting mode, switch the language with a single touch, and touch the setting twice to confirm the setting.



Figure 7.8

7.3.3.3 Set the COM Address

The default COM address is 1, continuous touch twice to enter the setting mode, single touch, number +1, continuous touch twice to confirm the setting, long press 5S digital to zero.

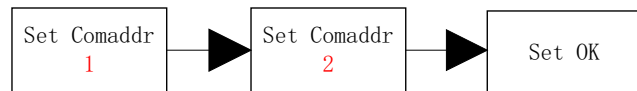



Figure 7.9

7.3.3.4 Set Date and Time

	After the storage time exceeds one month, the time and date set by the inverter may be incorrect. The inverter needs to be set before it is connected to the grid.
---	--

Touch twice to enter the parameter setting submenu, select the general setting, press twice to enter the general setting submenu, single touch to switch the display interface, touch the date and time interface twice to enter the setting state, single touch, number + 1, press twice to confirm the setting, long press 5S digital to zero.

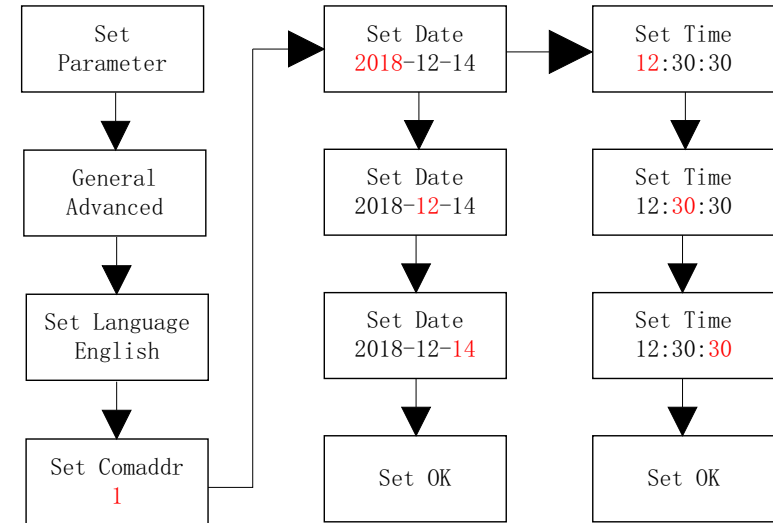

Figure 7.10

8. Monitoring Method

8.1 Remote Data Monitoring

MAC series inverter remote data monitoring methods include mobile APP and server WEB, RS485, GPRS, 4G can meet the above two monitoring methods.

8.1.1 Mobile APP (ShinePhone) remote monitoring

1. You can download and install the app by scanning the QR code below or by searching for "ShinePhone" in the Google/Apple store.



Figure 8.1

Note:

1. Make sure you are installing the latest version of the software.
2. For details, please refer to the contents on <http://server-cn.growatt.com>.
3. There are two ways to register your mobile phone APP :
 Method 1: Go to the mobile APP login page and click "One button to build a station". Scan the barcode to obtain the serial number of the collector, and complete the registration by filling in the mobile phone number, password, agent number and other information with one-click registration.
 Method 2: Go to the mobile APP login page and click on "Register".
 Registration is required to fill in the information, with an * is required. After completing the registration, you can log in to the main interface of ShinePhone. The registration page and main interface are as shown below:

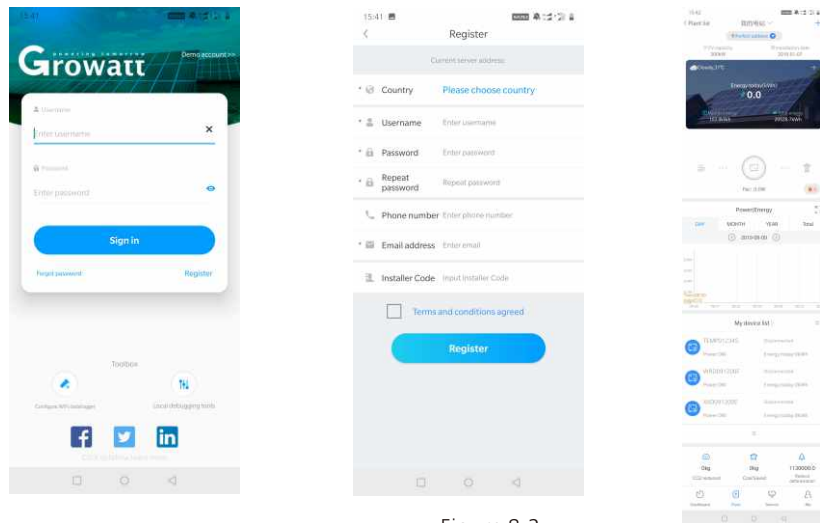
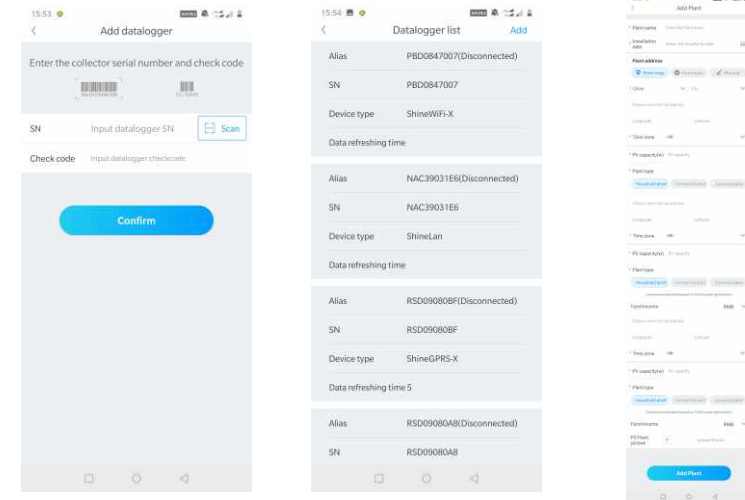

Figure 8.2

ShinePhone Main interface :

- 1>The center of the main interface shows the current power station name. You can switch between different power stations in the account by clicking the inverted triangle symbol.
- 2>Add a collector, view the collector, and add a power station by clicking the + sign in the upper right corner of the main interface.
- 3>The top of the main interface shows the total power, power generation and revenue of the current power plant's inverter.
- 4>"My device " shows the inverter of the current power station, click on the inverter name to enter the details interface, or you can top and edit it by left sliding. Editing includes modifying the alias and deleting the device.



Add collector interface

Collector list interface

Add power station interface

Figure 8.3

Collector:

- 1>Add a collector to add multiple collectors under the specified power station name.
 Way: click "+" on the top right corner to add datalogger (WiFi/GPRS etc) as 7.1.1 02(Note:
 If add wifi datalogger will need to configure it manually, scan the wifi datalogger for 2 seconds until a window pops up, then choose configure datalogger, APP will get the WIFI name , only need to input password and click set, around 30 seconds, the configuration will be done successfully.
- 2>User can add datalogger at the datalogger list page to add a datalogger, edit, delete, configure etc.
- 3>User can add more plants with the add Plant function.

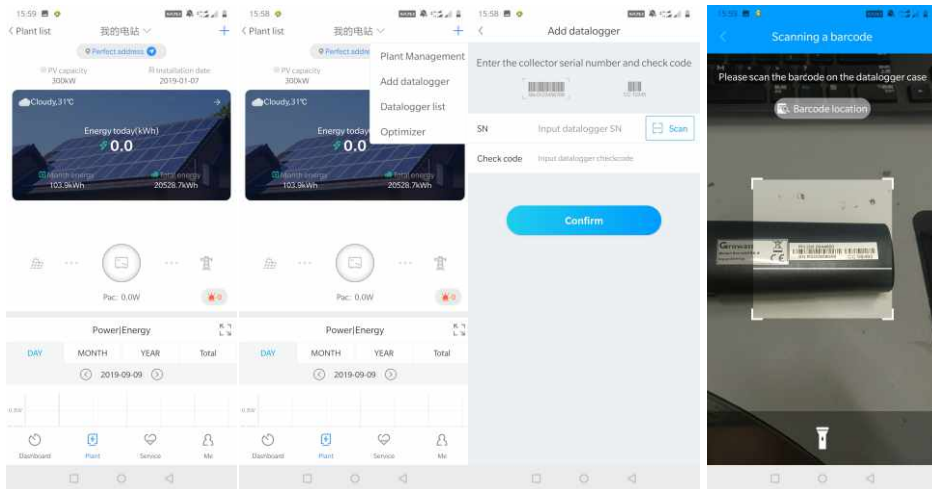

Figure 8.4

Inverter Details Page :

1>Click on the inverter name to enter the details main interface, which contains information about inverter power and power generation. Enter the control, log, edit, and parameter interface by clicking the icon below the interface.



Figure 8.5

2>Control: user set inverter on/off, set active power, set reactive power, set PF, set inverter time, set grid voltage high, set grid voltage low. The operation password is: inverter+date.

For example, if the date of the day is April 18, 2019, the password is inverter20190418.

3>Parameter interface: view the basic information such as the serial number, model, voltage, current and power of the inverter.

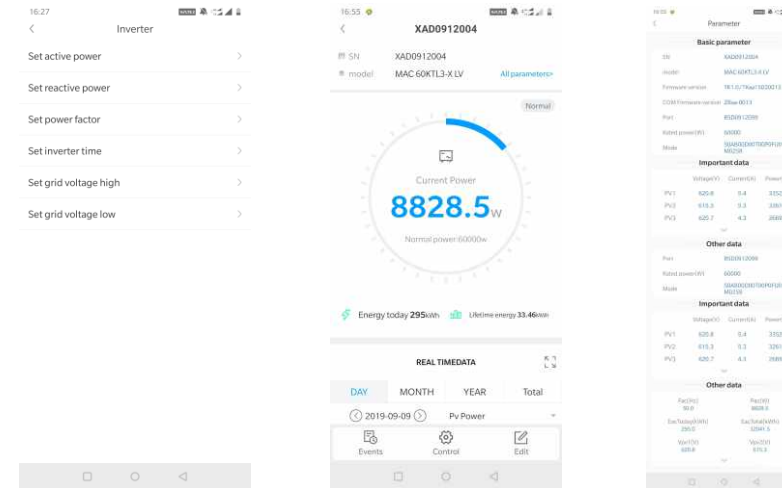

Figure 8.6

4>Data interface: View PV power, PV voltage, PV current, R phase power, S phase power, T phase power and output power of the inverter, and view detailed monitoring data by sliding up.

5>Log interface: View the fault information of the inverter.

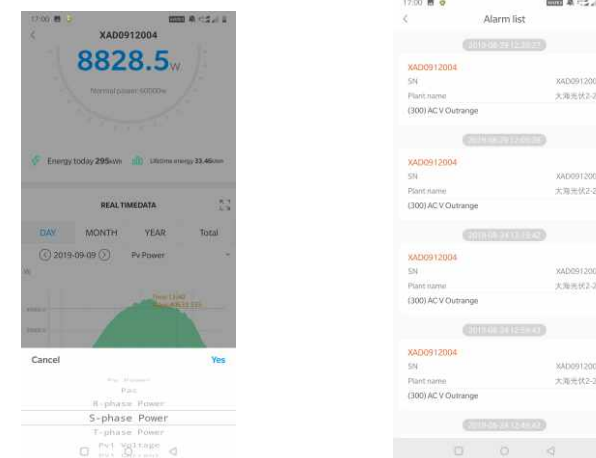

Figure 8.7

8.1.2 Server WEB webpage remote monitoring (ShineGPRS-X)

1. Register account

Open browser, input server.growatt.com, click "New User" at login page, input the necessary information then go back to login page, input the registered username and password, click login.

The registration form includes the following fields and options:

- Register type: **User** (selected), Installer, Distributor
- Country: [Text Input]
- Username: [Text Input]
- Password: [Text Input]
- Password confirm: [Text Input]
- Language: English (dropdown)
- E-Mail: [Text Input]
- Installer code: Enter the installer code or alias [Text Input]
- Agree with the Company's terms:
- Buttons: Register, Back to login

Figure 8.8

2. Add Collector

On the Plant page, click on "device list", "datalog", "add data logger", enter the SN number and verification code and save. datalogger will show after 5mins, also the device will come online.(The inverter is monitored by the collector, so the collector can be added)

The 'add data logger' dialog box contains the following fields:

- SN: [Text Input]
- verification: [Text Input]
- belongs: 我的电站 (dropdown)
- Buttons: cancel, save

The bottom screenshot shows the 'device list' table with the following data row highlighted:

No.	SN	alias	device type	user name	connect status	group	IP & Port	data update interval	device address
1	RSD09080A8	RSD09080A8	ShineGPRS-X	MAXtest	connection		/221.178.127.156:28009/		

Figure 8.9

3. View Plant and Inverter Information

A. Click on "Dashboard" to view related information such as "Day of Power Generation", "Cumulative Power Generation", "Today's revenue" and "Total revenue".

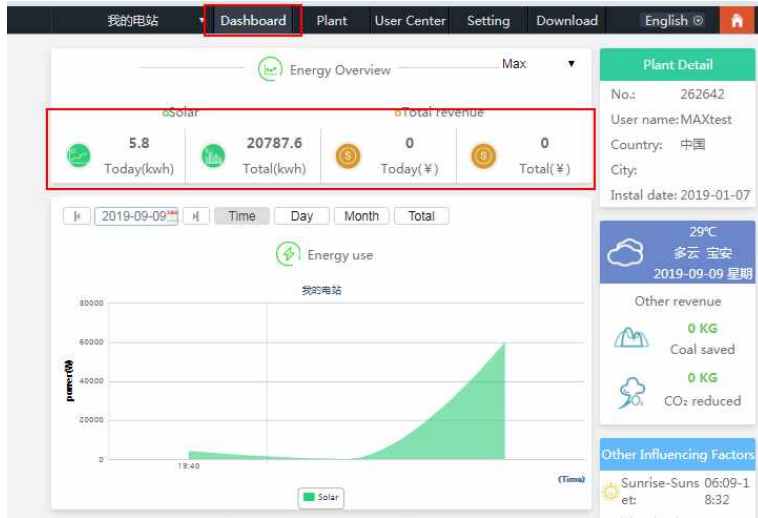

Figure 8.10

B. Click "plant" and "Plant data" to view the inverter power, voltage, current and other graphs.

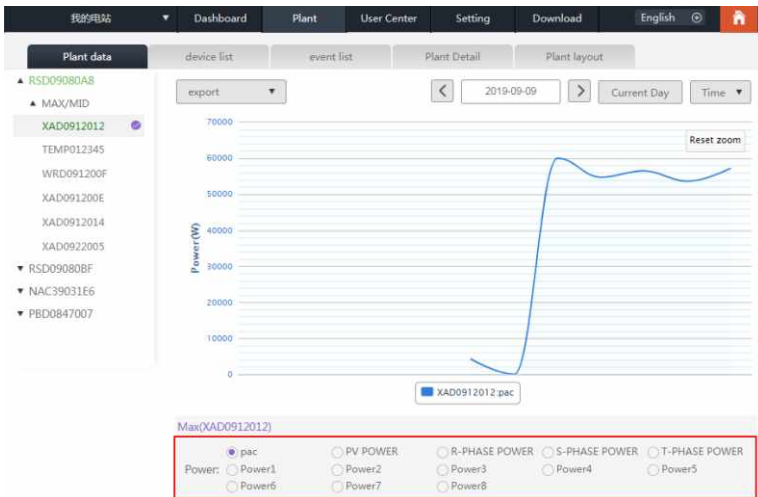

Figure 8.11

C. View detailed data

Click "Plant", "device list", "MAX/MID", and the inverter list of the power station is displayed. Double-click on the inverter name in the list to display the detailed data of the inverter. The data can be viewed by date or exported.

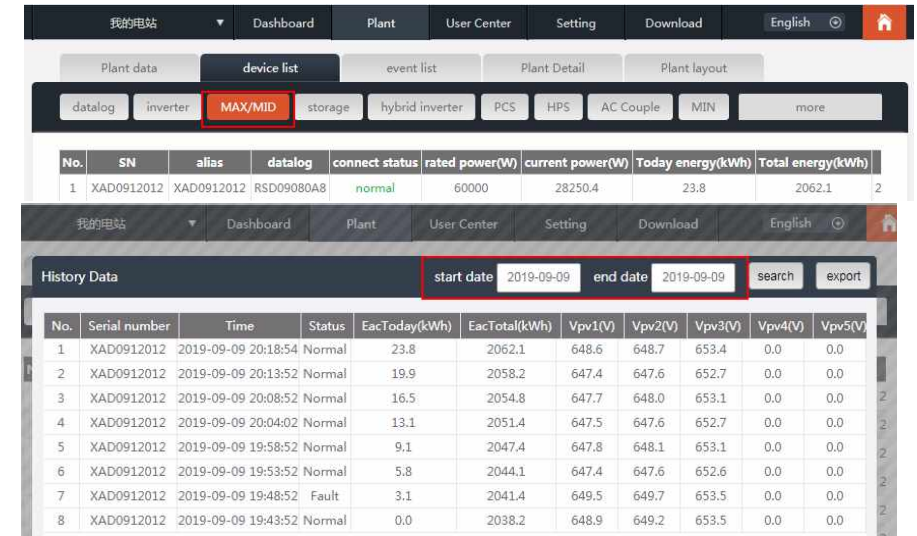

Figure 8.12

The inverter can be set by clicking the "Settings" operation key. The operation is performed by a professional, and the password is datalog+ current date. For example, if the date of the day is July 21, 2019, the password is datalog20190721.

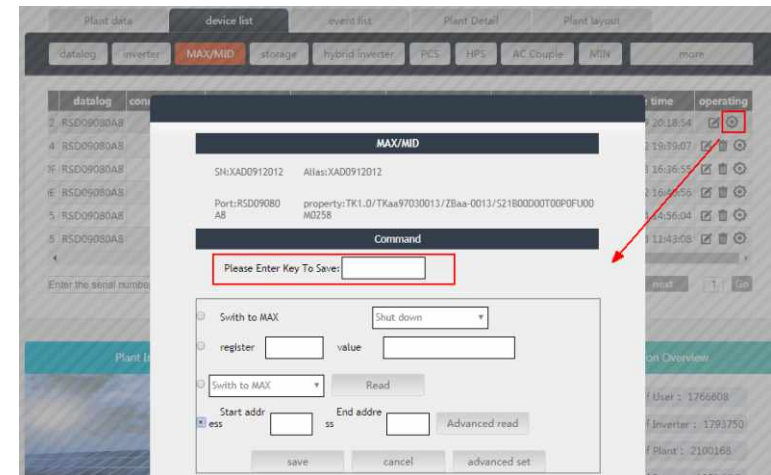

Figure 8.13

8.2 Local Data Monitoring

MAC series inverter local data monitoring can be realized by mobile phone APP, USB connected U disk.

8.2.1 Mobile phone app (Shinephone) Local Monitoring

8.2.1.1 Log on to app for local monitoring

1>Method 1

When you open the app login front page ,click the local debugging tool, and you can get the wifi name of the collector by scanning the QR code or barcode (The default password for WIFI is 12345678. If you have already connected, you can click "Skip" to connect directly to the WIFI.)

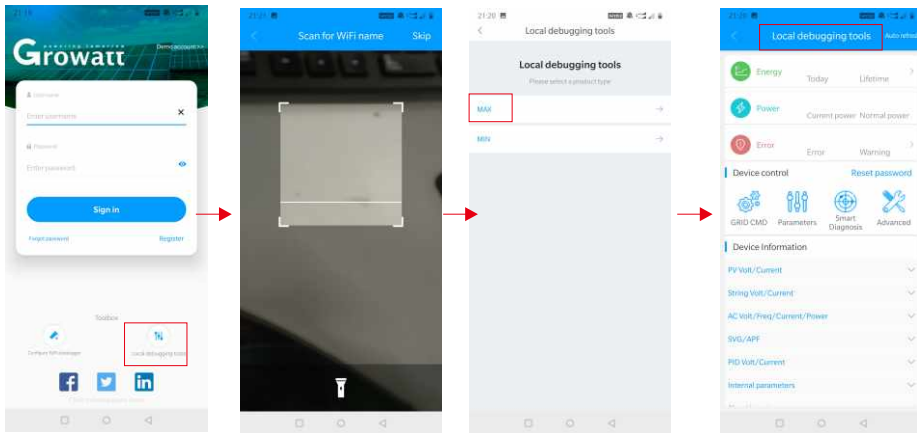

Figure 8.14

2>Method 2

Open app enter user name and password click login, enter me (personal center). Click the enter tool, find the local debugger to enter, and you can get the wifi name of the collector by scanning the QR code or barcode (The default password for WIFI is 12345678. If you have already connected, you can click "Skip" to connect directly to the WIFI.)

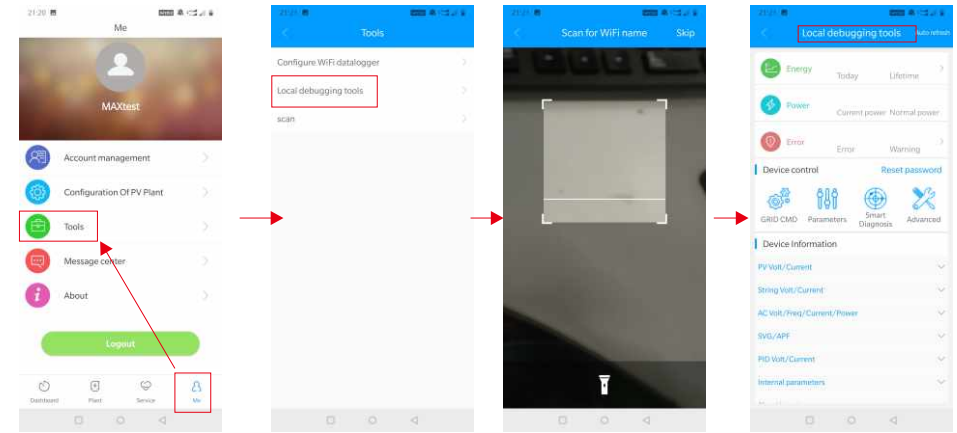

Figure 8.15

8.2.1.2 Local Monitoring and Debugging Use

When viewing local monitoring, you must keep the phone's wifi connected to the collector's wifi to view local monitoring (to enter the local monitoring page, first click auto refresh to get the latest data information. Electricity generation: the option to view the latest generation, daily generation, monthly and annual generation of detailed information; power: you can see the current power and rated power value; failure: can read the equipment detailed fault information;

Note:Please ask the professional to operate above.

1.device control

Note:In addition to resetting the password to connect to the network, other WiFi modules that must connect to the collector can view information.

A.Reset password

Need network connection login oss account to set up or modify the local debug password;

B.Setting configuration

The configuration data of inverter, voltage, power and so on can be modified according to the usage.

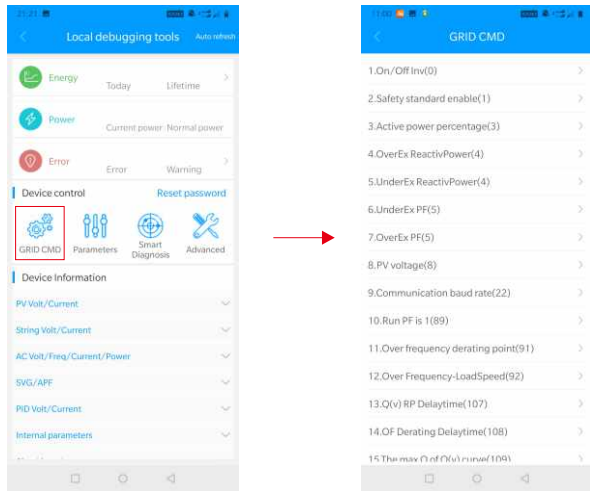

Figure 8.16

D. Intelligent detection

Detailed and accurate view of the device's detailed data and status .

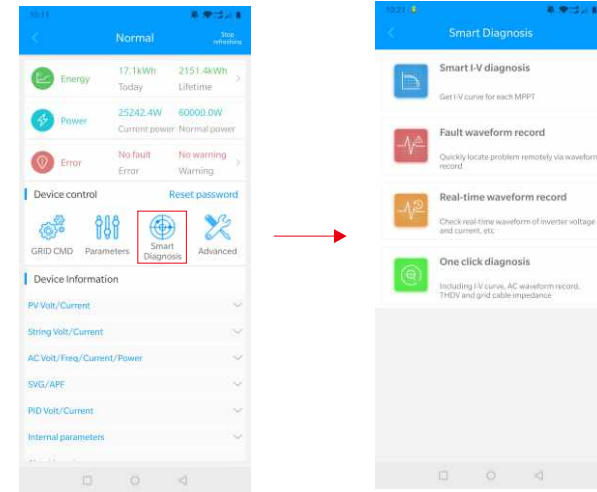

Figure 8.18

C. Parameter configuration

The parameter data of the equipment can be modified according to the usage .

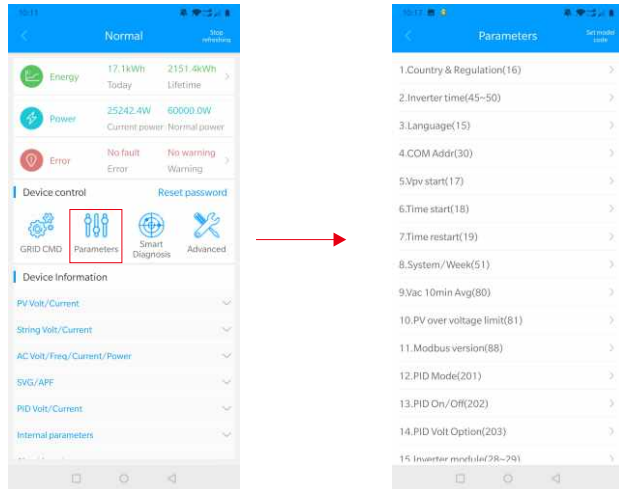

Figure 8.17

E. Intelligent I-V curve scanning

Can remotely scan each mppt.

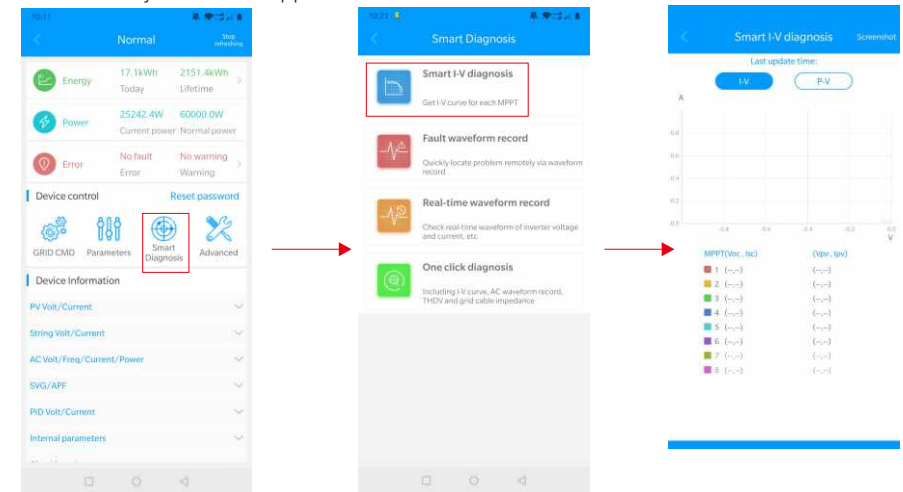

Figure 8.19

F. Fault recording detection
Remote, fast and accurate fault location.

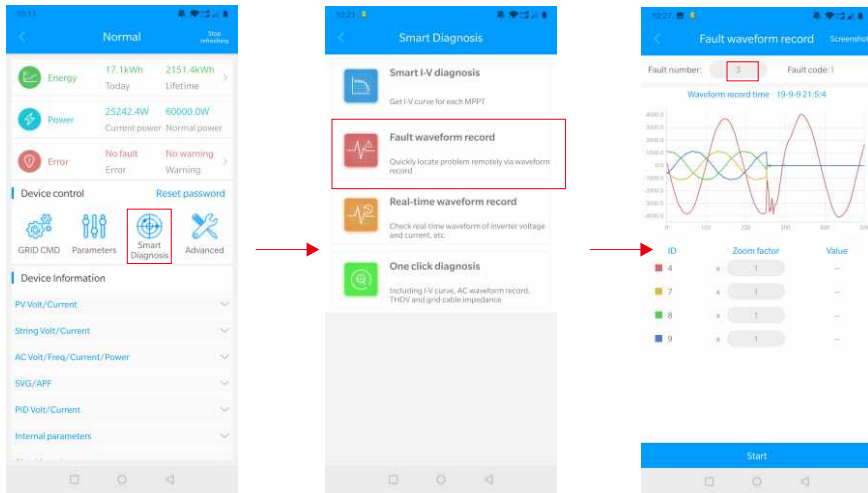
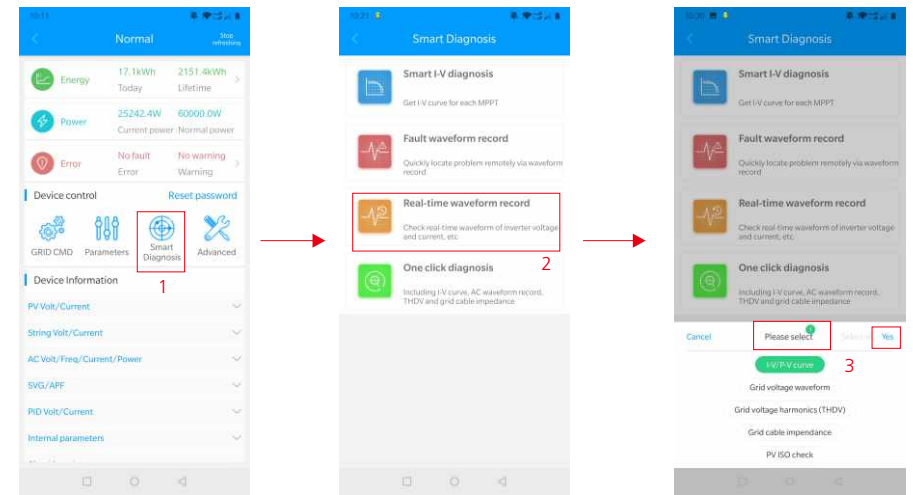

Figure 8.20

H. One-click diagnosis

One-button detection of power plant environment, including I-V curve diagnosis, grid waveform THDV and cable impedance detection.



G. Real-time recording detection
Inverter voltage and current quality can be observed in real time.

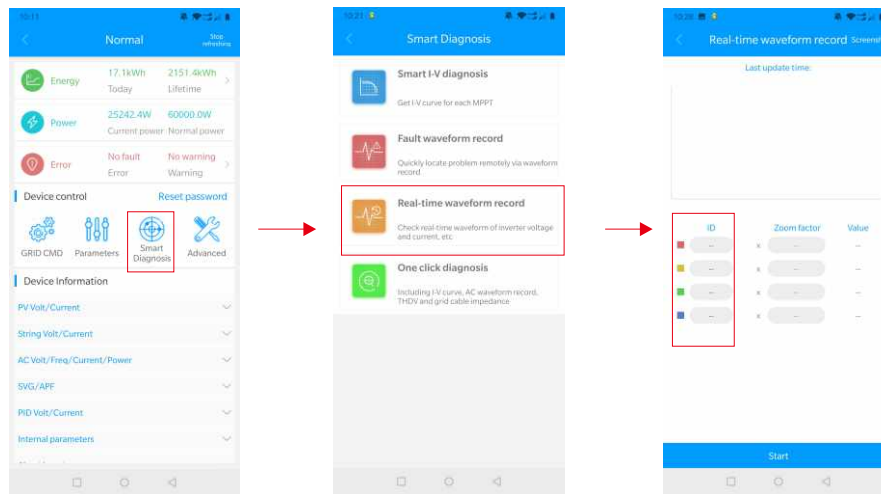

Figure 8.21

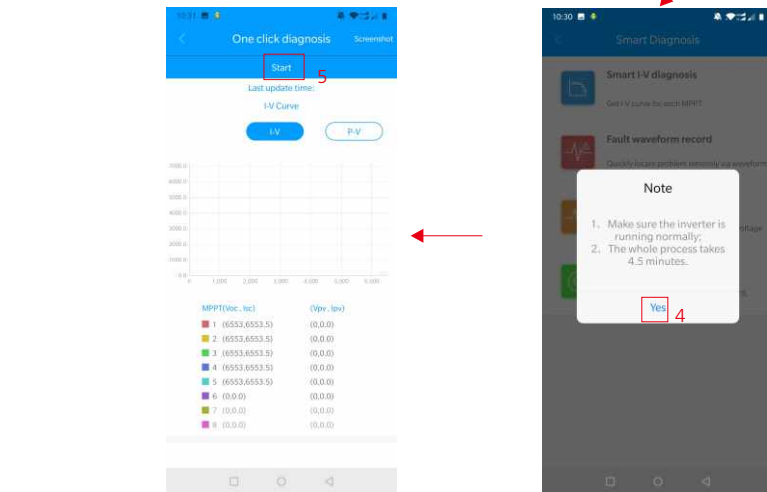

Figure 8.22

I.High level setting

According to register address set parameters (professional operation).

J.Device Information

Check PV voltage/current, string voltage/current, AC voltage/current/power/frequency, PID voltage/current, internal parameters, and detailed device detailed data information about the device.

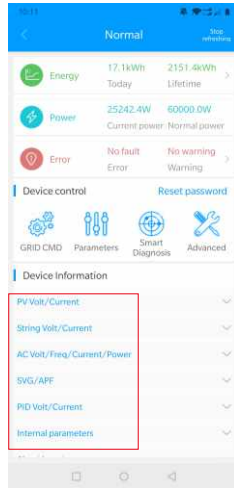

Figure 8.23

8.2.2 U Disk Monitoring

The local monitoring of U disk can realize the functions of software burning, fault recording, curve analysis and real-time recording. Details are as follows:

1.Firmware Programming

Create the bconfig.txt file under the root of the U disk, write to the following content, then insert the U disk to programming. Note the M3 program needs to be programming at last time.

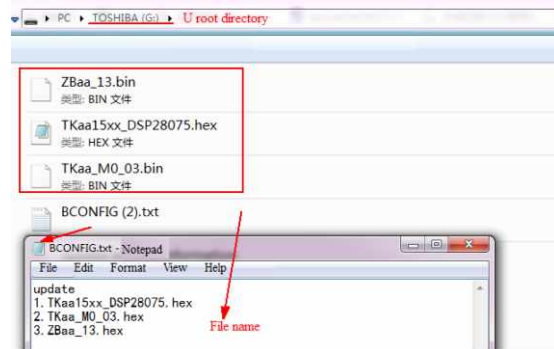

Figure 8.24

2.Fault Recording

Create a BCONFIG.txt file under the root directory of the USB flash drive, write "down_fault", insert the USB flash drive to read the fault recording information, and store a total of 100 fault recording information in the root directory. The latest number is 0.

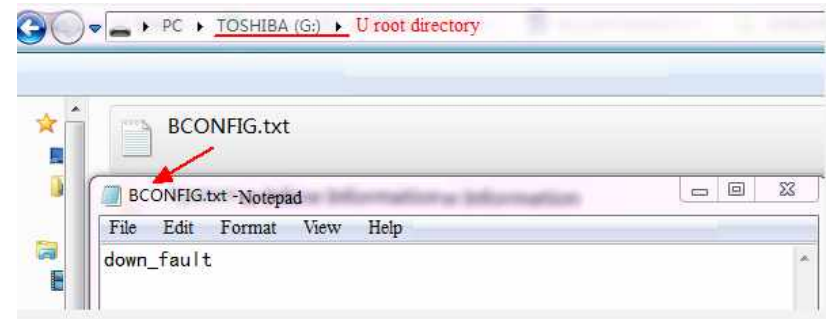

Figure 8.25

3.Curve Analysis

Create the bconfig.txt file under the root of the U disk, write the following content, the insert U disk to record I-V curve, then generates a form under the files in the root directory.

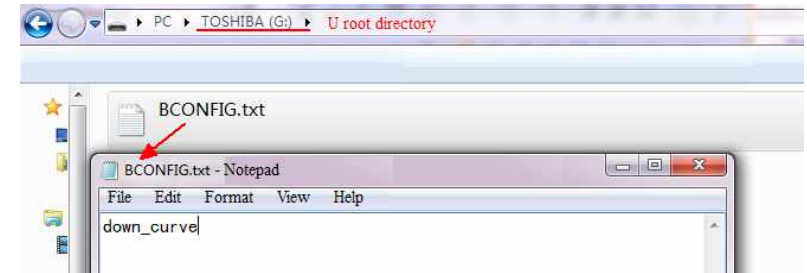

Figure 8.26

4.Real Time Recording

Create the bconfig.txt file under the root of the U disk, write the following content, then insert

U disk to read real time recording information , then generates a form under the files in the root directory , the form record's waveform is consistent with the ID of the command setting.

System Maintenance 9



9.1 Routine Maintenance

9.1.1 Cleaning Inverter

 DANGER	<ul style="list-style-type: none">● Before any operation, please disconnect the DC switch and AC switch, and wait for at least 5 minutes until internal capacitance discharge completely.
---	---

- 1>Check the ambient temperature and dust of the inverter, clean the inverter when necessary.
- 2>Observe whether the air outlets is normal, when necessary, clean the air outlets or clean the fan step by step, steps refer to 9.1.2

9.1.2 Fan Maintenance

 DANGER	<ul style="list-style-type: none">● It must be carried out by qualified, trained personnel and comply with all prevailing local code and regulations.● Please disconnect the DC switch and AC switch before any operation, and wait for at least 5 minutes until the internal bus capacitance discharge completely.
 WARNING	<ul style="list-style-type: none">● Do not use the air pump cleaning fan, which may cause fan damage.

When the Growatt Max series inverter work in high temperature environment, good ventilation and heat dissipation can effectively reduce the chance of load derating . Inverter equipped with internal cooling fans, when the internal temperature is too high, the fans work in to reduce the internal temperature. When the inverter is derating because of the internal temperature is too high, the following are the possible reasons or solutions;

- Fan is blocked or the heat sink gathers too much dust, it needs to clean the fan, fan cover or heat sink.
- Fan is damaged, it need to replace the fan.
- Poor ventilation of the installation location, it needs to select the appropriate installation location according to the basic installation requirements.

Fan cleaning and replacement procedure.

1>Please ensure that the DC side and AC side of the inverter have been disconnected before cleaning or replacement of the fan.

- Turn off DC switch.
- Disconnect DC terminals from inverter(Users need tools to disconnect the DC connection terminals)
- Turn off AC switch ;

2>Remove the screws on the fan guards with a cross screwdriver. it is shown as below

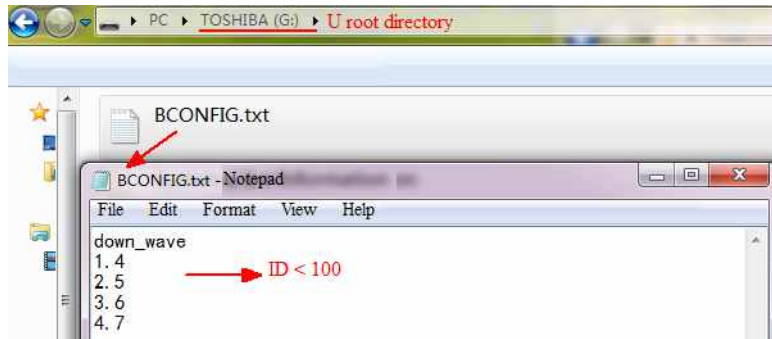

Figure 8.27

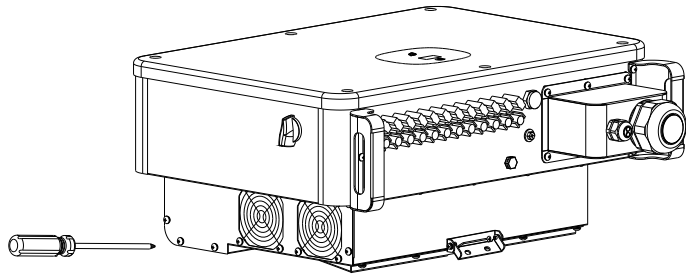

Figure 9.1

3>Disconnect the wire connector of the fans with a flat head screw driver and remove the fans from the fan guards, it is shown as below.

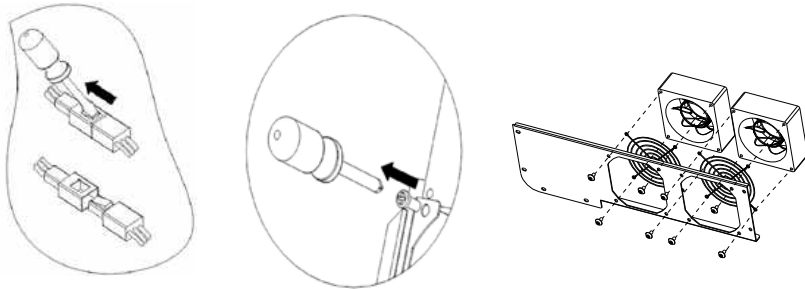

Figure 9.2

4>Clean fan, fan guards and heat sink or replace fan.

- Clean the fan and fan guards with air pump, brush or a damp cloth.
- Remove each fan separately for cleaning if necessary.
- Remove the fan that need to replace with a cross screwdriver, replace a new fan.
- Tidy up the wire.

5>Install the fan, fan guard fixed and the inverter again.

9.2 Trouble Shooting

	<ul style="list-style-type: none"> ●Work on the Growatt Max must be carried out by qualified personnel. ●Normally grounded conductors may be ungrounded and energized when a PV isolation low is indicated. ●Risk of electric shock
--	--

9.2.1 Warning

Warnings identify the current status of the inverter(Max), warnings do not related to a fault and it does not affect the normal running of the inverter. When a warning with a number after it appears in the display, it indicates a warning code and is usually cleared through an orderly shutdown/re-set or a self-corrective action performed by the inverter. See the warning code in the following table;

Warning Message	Description	Suggestion
Warning 200	String fault	1. After shutdown, Check the panel is normal. 2. If error message still exists, contact manufacturer.
Warning 202	DC SPD function abnormal	1. After shutdown, Check the DC SPD. 2. If error message still exists, contact manufacturer.
Warning 203	PV Circuit short	1. Check the PV1 or PV2 wiring is short-circuited. 2. If error message still exists, contact manufacturer.
Warning 206	AC SPD function abnormal	1. After shutdown, Check the AC SPD. 2. If error message still exists, contact manufacturer.
Warning 207	U disk over-current protection	1. unplug the U disk 2. Re-access U disk after shutdown 3. If the error message still exists, contact manufacturer.
Warning 400	Fan function abnormal	1. After shutdown, Check the fan connection. 2. Replace the fan. 3. If the error message still exists, contact manufacturer.
Warning 401	Meter abnormal	1. Check if the meter is on 2. Check the machine and the meter connection is normal
Warning 402	Optimizer and inverter communication is abnormal	1. Check if the optimizer is on. 2. Check whether the connection between the optimizer and the inverter is normal
Warning 404	EEPROM abnormal	1. Restart inverter. 2. If error message still exists, contact manufacturer.
Warning 405	DSP and COM firmware version unmatch	1. Check the firmware version. 2. If error message still exists, contact manufacturer.
Warning 408	NTC Broken	1. Restart inverter 2. If error message still exists, contact manufacturer.

If the above suggestions do not work, please contact Growatt.

9.2.2 Error

Errors codes identify a possible equipment failure, fault or incorrect inverter setting or configuration, any or all attempts to correct or clear a fault must be performed by qualified personnel.

Typically, the error code can be cleared once the cause or fault is removed.

Some of error code as table shows below, may indicate a fatal error and require you to contact the supplier or Growatt for help.

Error Code	Description	Suggestion
Error 200	AFCI Fault	1.After shutdown,Check the panel terminal. 2.Restart inverter. 3.If error message still exists,contact manufacturer.
Error 201	Leakage current too high	1.Restart inverter. 2.If error message still exists,contact manufacturer.
Error 202	The DC input voltage is exceeding the maximum tolerable value.	1.Immediately disconnect the DC switch and check the voltage 2:.If the fault code still exists after the normal voltage is restored, contact manufacturer
Error 203	PV Isolation Low	1.After shutdown,Check if panel enclosure ground properly. 2.If error message still exists,contact manufacturer
Error 300	AC V Outrange	1.Check grid voltage. 2.If the error message still exists despite the grid voltage being within the tolerable range, contact
Error 302	No AC Connection	1.After shutdown,Check AC wiring. 2.If error message still exists,contact manufacturer
Error 303	PE abnormal	1.Check PE,to ensure that the PE line contact good. 2.If error message still exists,contact Manufacturer
Error 304	AC F Outrange	1.Restart inverter. 2.If error message still exists,contact manufacturer.

Error 402	Output DC current too high	1.Restart inverter. 2.If error message still exists,contact manufacturer.
Error 403	Output current unbalance	1. After shutdown,Check the output current is not balanced. 2.If the error message still exists, contact manufacturer
Error 404	bus sample fault	1.Restart inverter. 2.If error message still exists,contact manufacturer.
Error 405	Relay fault	1.Restart inverter. 2.If error message still exists,contact manufacturer
Error 408	NTC Temperature too high	1.After shutdown,Check the temperature, normal restart the inverter 2.If the error message still exists, contact manufacturer
Error 409	Bus voltage abnormal	1.Restart inverter. 2.If error message still exists,contact manufacturer.
Error 411	Communication fault	1.After shutdown,Check communication board wiring 2. If the error message still exists, contact manufacturer
Error 413	IGBT drive fault	1.Restart inverter. 2.If error message still exists,contact manufacturer
Error 415	Internal power test fail (PV Power low)	1.Restart inverter. 2.If error message still exists,contact manufacturer
Error 416	Over current protected by software	1.Restart inverter. 2.If error message still exists,contact manufacturer.
Error 420	GFCI Module damage	1.After shutdown,Check the leakage current module 2 .If the error message still exists, contact manufacturer
Error 422	sampling is inconsistent	1.Restart inverter. 2.If error message still exists,contact manufacturer

Technical Data10

Error 425	AFCI self-test fault	1.Restart inverter 2.If error message still exists, contact manufacturer.
Error 426	PV Curr Sample Fault	1.Restart inverter 2.If error message still exists, contact manufacturer.
Error 427	AC Curr Sample Fault	1.Restart inverter 2.If error message still exists, contact manufacturer.

Model	MAC 30KTL3-X LV	MAC 40KTL3-X LV	MAC 50KTL3-X LV	MAC 60KTL3-X LV
Input data				
Max.recommended PV PV power(for module STC)	39000W	52000W	65000W	78000W
Max. DC voltage	1100V			
Start voltage	250V			
Nominal voltage	600V			
MPP voltage range	200V-1000V			
Full load MPP voltage	600V-850V			
Max. input current per per MPP trackers	37.5A/37.5A /25A	37.5A/37.5A /37.5A	50A/37.5A/ 37.5A	50A/50A/ 50A
Max. short-circuit current per MPP trackers	45A/45A/ 45A	45A/45A/ 45A	55A/55A/ 55A	55A/55A/ 55A
No. of MPP trackers	3			
No. of PV strings per MPP trackers	3/3/2	3/3/3	4/3/3	4/4/4
Output Data(AC)				
AC nominal power	30000W	40000W	50000W	60000W
Max. AC apparent power	33300VA	44400VA	55500VA	66600VA
Nominal AC voltage/range	230V/400V/340-440VAC			
AC grid frequency/range	50/60 Hz 45~55Hz/55-65 Hz			
Max. output current	43.5A (cos φ=1) 48.3A (cos φ=0.9)	58.0A (cos φ=1) 64.4A (cos φ=0.9)	72.5A (cos φ=1) 80.5A (cos φ=0.9)	87.0A (cos φ=1) 96.6A (cos φ=0.9)

Power factor(@nominal power)	>0.99 (0.8LG ...0.8LD)
THDi	<3%
AC grid connection type	3W/N/PE
Efficiency	
Max. efficiency	98.80%
MPPT efficiency	99.90%
Protection devices	
DC reverse polarity protection	YES
DC switch	YES
DC Surge protection	YES (Class II)
Insulation resistance monitoring	YES
RCD check (GFCI)	YES
AC short-circuit protection	YES
AC surge protection	YES (Class II)
Interfaces	
Display	OLED+LED/WIFI+APP
USB	YES
Rs485	YES
WIFI	Option
GPRS	Option
4G	Option
General Data	
Dimensions (W / H / D)	680*508*281 mm
Weight	52kg

Operating temperature range	- 25°C ... +60°C (derating over 45°C)
Noise emission (typical)	≤60dB(A)
Relative humidity	0~100%
Highest Altitude	4000m
Self-Consumption night	< 1W
Topology	Transformerless
Cooling concept	Fan cool
Environmental Protection Rating	Ip65
Warranty:	5 years/10years (Option)
Certificates and approvals	
Safety /EMC	EN 61000-3, EN 61000-6, EN/IEC 62109-1, EN/IEC 62109-2,

Model	MAC 50KTL3-X MV	MAC 60KTL3-X MV	MAC 66KTL3-X MV	MAC 70KTL3-X MV
Input data				
Max. recommended PV PV power(for module STC)	65000W	78000W	85800W	91000W
Max. DC voltage	1100V			
Start voltage	250V			
Nominal voltage	700V			
MPP voltage range	200V-1000V			
Full load MPP voltage	650V-850V			
Max. input current per per MPP trackers	50A/37.5A/ 37.5A	50A/50A/ 50A	50A/50A/ 50A	50A/50A/ 50A
Max. short-circuit current per MPP trackers	55A/55A/ 55A	55A/55A/ 55A	55A/55A/ 55A	55A/55A/ 55A
No. of MPP trackers	3			
No. of PV strings per MPP trackers	4/3/3	4/4/4	4/4/4	4/4/4
Output Data(AC)				
AC nominal power	50000W	60000W	66000W	70000W
Max. AC apparent power	55500VA	66600VA	73300VA	77700VA
Nominal AC voltage/range	277V/480V/425-540VAC			
AC grid frequency/range	50/60 Hz 45~55Hz/55-65 Hz			
Max. output current	60.2A (cos φ=1) 66.9A (cos φ=0.9)	72.2A (cos φ=1) 80.2A (cos φ=0.9)	79.4A (cos φ=1) 88.2A (cos φ=0.9)	84.2A (cos φ=1) 93.6A (cos φ=0.9)

Power factor(@nominal power)	>0.99 (0.8LG ...0.8LD)
THDi	<3%
AC grid connection type	3W/N/PE
Efficiency	
Max. efficiency	98.80%
MPPT efficiency	99.90%
Protection devices	
DC reverse polarity protection	YES
DC switch	YES
DC Surge protection	YES (Class II)
Insulation resistance monitoring	YES
RCD check (GFCI)	YES
AC short-circuit protection	YES
AC surge protection	YES (Class II)
Interfaces	
Display	OLED+LED/WIFI+APP
USB	YES
Rs485	YES
WIFI	Option
GPRS	Option
4G	Option
General Data	
Dimensions (W / H / D)	680*508*281 mm
Weight	52kg

Operating temperature range	- 25°C ... +60°C (derating over 45°C)
Noise emission (typical)	≤ 60dB(A)
Relative humidity	0~100%
Highest Altitude	4000m
Self-Consumption night	< 1W
Topology	Transformerless
Cooling concept	Fan cool
Environmental Protection Rating	Ip65
Warranty:	5 years/10years (Option)
Certificates and approvals	
Safety /EMC	EN 61000-3, EN 61000-6, EN/IEC 62109-1, EN/IEC 62109-2,

For Brazilian only

Model	MAC 15KTL3-XL	MAC 20KTL3-XL	MAC 22KTL3-XL
Input data			
Max.recommended PV PV power(for module STC)	19500W	26000W	28600W
Max. DC voltage	1100V		
Start voltage	250V		
Nominal voltage	360V		
MPP voltage range	200V-1000V		
No. of MPP trackers	3		
No. of PV strings per MPP trackers	4/4/4		
Max. short-circuit current per MPP trackers	50A/50A/50A		
Max. input current per per MPP trackers	55A/55A/55A		
Output Data(AC)			
AC nominal power	15000W	20000W	22000W
Max. AC apparent power	16600kVA@ 220VAC	22200kVA@ 220VAC	24400kVA@ 220VAC
Nominal AC voltage/range	127V/220V,101.6-139.7V		
AC grid frequency/range	50/60 Hz,45~55Hz/55-65 Hz		
Nominal output current	39.4A	52.5A	57.7A
Max. output current	46.3A	58.3A	64.0A

Power factor(@nominal power)	>0.99 (0.8LG ...0.8LD)		
THDi	<3%		
AC grid connection type	3W/N/PE		
Efficiency			
Max. efficiency	98.80%		
Euro efficiency	98.2%	98.2%	98.2%
Protection devices			
DC reverse polarity protection	YES		
DC switch	YES		
DC Surge protection	YES (Class II)		
Insulation resistance monitoring	YES		
RCD check (GFCI)	YES		
AC short-circuit protection	YES		
AC surge protection	YES (Class II)		
Interfaces			
Display	OLED+LED/WIFI+APP		
USB	YES		
Rs485	YES		
WIFI	Option		
GPRS	Option		
4G	Option		
General Data			
Dimensions (W / H / D)	680*508*281 mm		
Weight	52kg		

Operating temperature range	- 25°C ... +60°C (derating over 45°C)
Noise emission (typical)	≤60dB(A)
Relative humidity	0~100%
Highest Altitude	4000m
Self-Consumption night	< 1W
Topology	Transformerless
Cooling concept	Fan cool
Environmental Protection Rating	Ip65
Warranty:	5 years/10years (Option)
Certificates and approvals	
Safety /EMC	EN 61000-3, EN 61000-6, EN/IEC 62109-1, EN/IEC 62109-2,

Model	MAC 25KTL3-XL	MAC 30KTL3-XL	MAC 36KTL3-XL
Input data			
Max. recommended PV PV power(for module STC)	32500W	39000W	46800W
Max. DC voltage	1100V		
Start voltage	250V		
Nominal voltage	360V		
MPP voltage range	200V-1000V		
No. of MPP trackers	3		
No. of PV strings per MPP trackers	4/4/4		
Max. short-circuit current per MPP trackers	50A/50A/50A		
Max. input current per per MPP trackers	55A/55A/55A		
Output Data(AC)			
AC nominal power	25000W	30000W	36000W
Max. AC apparent power	27800kVA@ 220VAC	33300kVA@ 220VAC	36000kAV@ 220VAC 39200kVA@ 240VAC
Nominal AC voltage/range	127V/220V,101.6-139.7V		
AC grid frequency/range	50/60 Hz,45~55Hz/55-65 Hz		
Nominal output current	65.6A	78.8A	94.5A
Max. output current	73.0A	87.4A	94.5A

Power factor(@nominal power)	>0.99 (0.8LG ...0.8LD)		
THDi	<3%		
AC grid connection type	3W/N/PE		
Efficiency			
Max. efficiency	98.80%		
Euro efficiency	98.2%	98.3%	98.5%
Protection devices			
DC reverse polarity protection	YES		
DC switch	YES		
DC Surge protection	YES (Class II)		
Insulation resistance monitoring	YES		
RCD check (GFCI)	YES		
AC short-circuit protection	YES		
AC surge protection	YES (Class II)		
Interfaces			
Display	OLED+LED/WIFI+APP		
USB	YES		
Rs485	YES		
WIFI	Option		
GPRS	Option		
4G	Option		
General Data			
Dimensions (W / H / D)	680*508*281 mm		
Weight	52kg		

Operating temperature range	- 25°C ... +60°C (derating over 45°C)
Noise emission (typical)	≤ 60dB(A)
Relative humidity	0~100%
Highest Altitude	4000m
Self-Consumption night	< 1W
Topology	Transformerless
Cooling concept	Fan cool
Environmental Protection Rating	Ip65
Warranty:	5 years/10years (Option)
Certificates and approvals	
Safety /EMC	EN 61000-3, EN 61000-6, EN/IEC 62109-1, EN/IEC 62109-2,

Decommissioning 11

If the inverter does not operate in the future, it needs to be properly disposing. The steps are as follows:

- 1>Disconnect the external AC short circuit and prevent reconnection due to misoperation.
- 2>Turn the DC switch to "OFF" position.
- 3>Wait at least 5 minutes until the internal capacitor discharge is completed.
- 4>Disconnect the AC connector.
- 5>Disconnect DC connector.
- 6>Remove the inverter from the wall.
- 7>Disposing of the inverter.

12 Quality assurance

Please refer to related file.

13 Contact

If you have technical problems concerning our products, contact your installer or Growatt, please provide information below for better support.

- 1>Inverter type
- 2>Serial number of inverter
- 3>Error code of inverter
- 4>LED status of inverter
- 5>DC input voltage of inverter (Modules information)
- 6>Inverter communication method

SHENZHENGROWATTNEWENERGYTECHNOLOGYCO.,LTD
No.28GuangmingRoad,ShiyanStreet,Bao'anDistrict,Shenzhen,P.R.China

T: +86 755 27471942
E: service@ginverter.com
W: www.ginverter.com